

A Bouquet For You

By Hazel Lee

I have given instructions for making all the flowers and leaves necessary for this bouquet, but assembly of the bouquet has been left to your own individual taste using the picture for guidance if required.

Materials Required:

2mm quilling paper in the following colours;
Medium green - 6 strips, Blue - 3 strips,
Pale blue - 2 strips, Bright yellow - 2 strips,
Orange - 1 strip, White - 4 strips,
Sage green - 5 strips.

3mm quilling paper in the following colours;
Lilac - 1 strip, Purple - 1 strip,
Pale green - 2 strips, Gold edged Peach - 1 strip.

5mm quilling paper in the following colours;
Bright yellow - 1 strip.

10mm quilling paper in the following colours;
Medium green - 1 strip.

Dark Rose paper 25mm x 100mm;

24 punched paper circles.

Pink wide quilling paper or sheet.

25mm x 100mm clean scrap paper.

Quilling tool, Hole punch, Scissors.

P.V.A. Craft adhesive.

Card Mount - AP51P.

To Make The Card:

Bell Sprays:

Cut the strip of 3mm lilac paper into eight equal lengths. Make these into tight coils and push into bell shapes using a cocktail stick. Glue them inside to keep the shape. Do the same with the strip of 3mm purple paper.

Tight coil - made by winding paper and glueing closed before removing from tool.

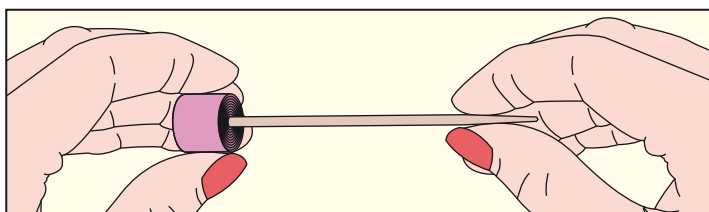
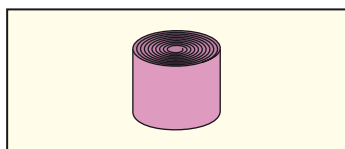

Hold the coil in left hand and gently push the centre out with a cocktail stick to the right length.

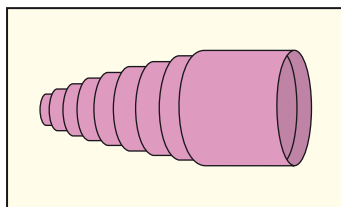

Place a little glue inside the finished bell to ensure it does not get pushed in again.

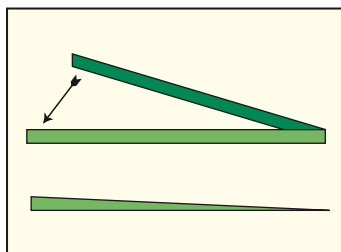

Stick two strips of sage green 2mm paper together to make the stems and taper one end.

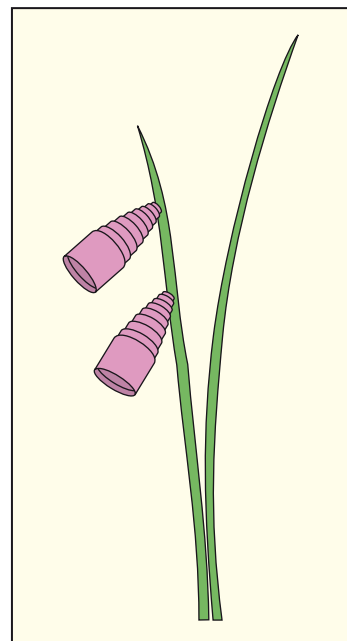

Make into one large lilac spray and two small purple sprays, using the illustration as a guide.

Forget-Me-Nots:

Cut three 2mm blue strips, two 2mm pale blue strips and one 2mm bright yellow strip into 16 equal pieces and make 48 blue, 24 pale blue and 12 bright yellow tight coils. Make these into 12 florets with yellow centres.

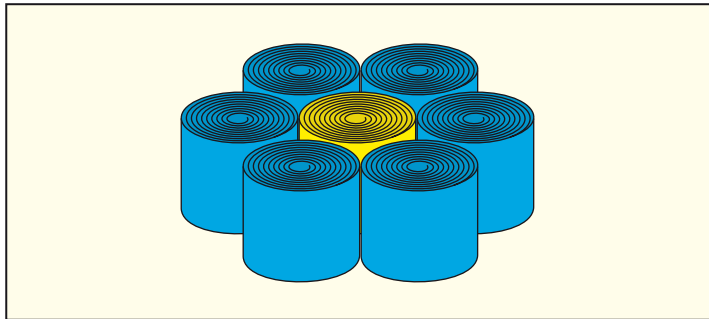

Peach Spray:

This shape is a 'Loose Coil' and from this you can make various other shapes which, when put together, make up your design.

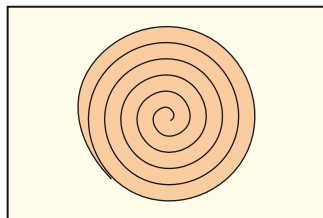

Cut the gold edged peach paper into eight pieces, make loose coils and pinch to arrowhead shapes.

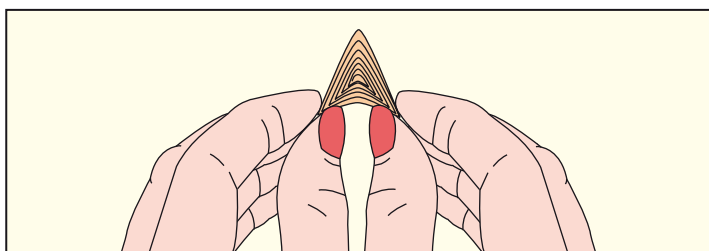
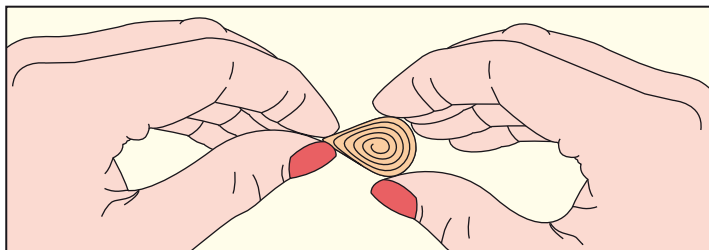

Tear one strip of sage green 2mm paper into twelve pieces and make into eye shapes for leaves by pinching both ends of a loose coil. Make the stems from two strips stuck together. Arrange the flowers and leaves along the stems.

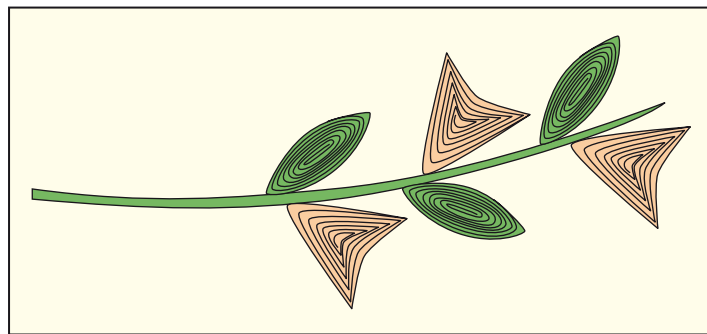
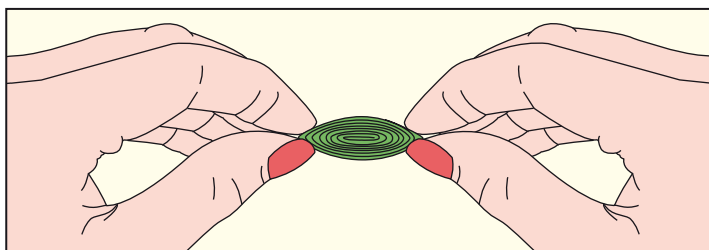

Roses:

Using the wide pink quilling paper or a sheet of paper draw around a 5 pence piece and cut it out. Cut a spiral as shown and start rolling on the tool from the outside point, which will become the centre of the rose. Glue this coiled rose centre to a small piece of paper. Glue the punched circles around it taking care to only glue inside edge leaving outside edges free. When completely dry cut the backing paper away close to the flower.

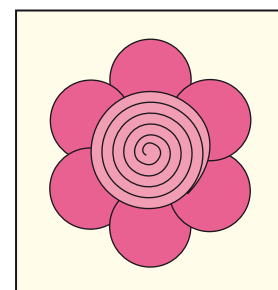
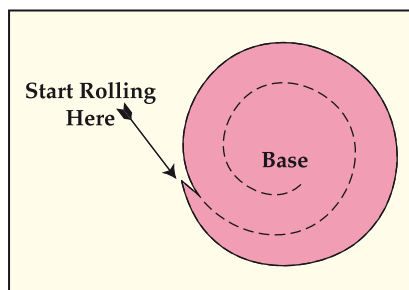

Fringe Flowers:

Cut the 5mm bright yellow strip into quarters and snip vertical slots along one edge about three quarters of the depth, making slots as fine as possible. Make a tight coil with 4cm of 2mm orange paper and keeping it on the tool stick it to edge of a fringe, roll up and glue end down. Push the flower off the tool with both thumb nails (do not pull or it may unwind) and add a touch of glue to the base. Make another 2 in the same way. When dry pull the fringe down with your thumb nail.

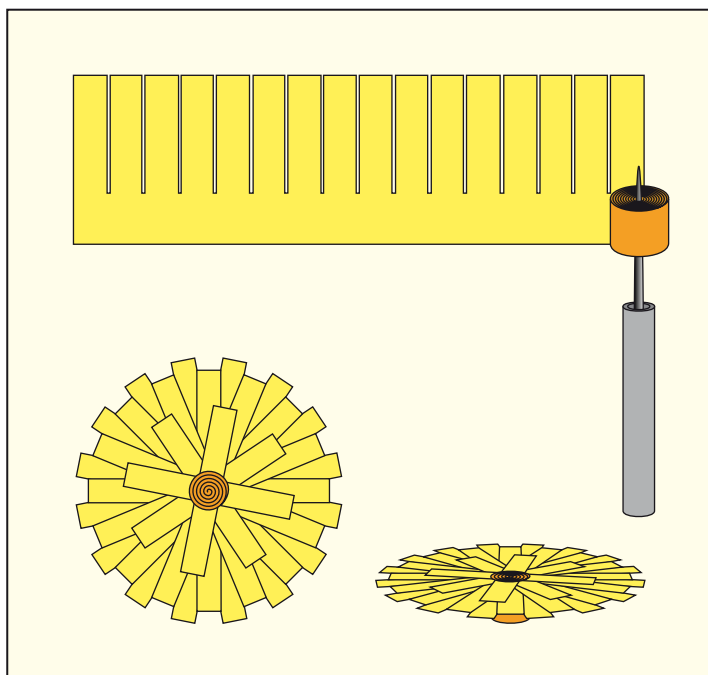

Lily Of The Valley:

Make four of these in different lengths. To make the flowers, take three white 2mm strips and divide one into eighths, one into twelfths and one into sixteenths. Make all the pieces into loose coils and shape by pressing coil around the tool handle. Cut some small lengths of white and make a few tight coils for the top buds.

Stick two strips of green 2mm paper together, cut to lengths to make stems and stick the flowers along the edges. See large illustration.

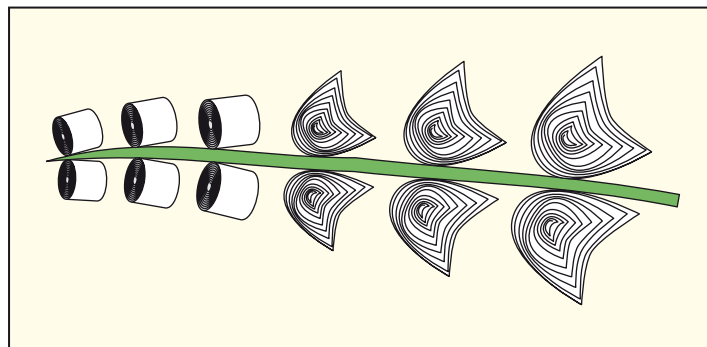
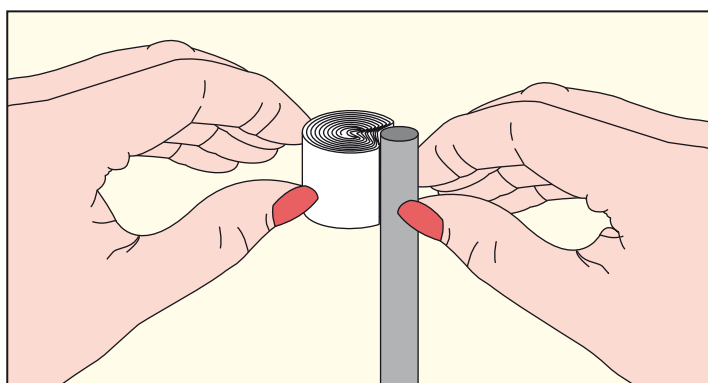

Various Leaves:

Make some eye shaped leaves in various sizes using 2mm green strips. Divide 2 strips into four, six and eight, then make loose coils and pinch into shape. Use these small leaves to fill gaps in your arrangement when assembling the bouquet.

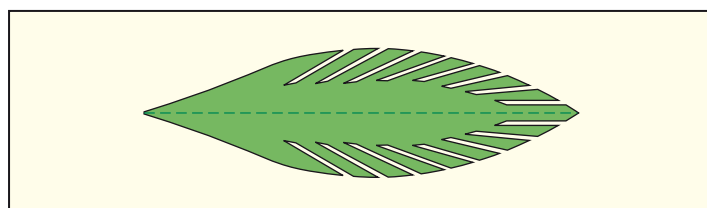

Make three fringed leaves approximately 25mm long and one approximately 32mm long from green 10mm paper, fold along the middle, cut to shape and fringe, twist to give shape.





Craft CREATIONS^{Ltd} Magazine

Hello,

We hope you enjoy this free article taken from a back issue of the Craft Creations Magazine. You may hand make copies of the card(s) featured in this project, to give away or sell, as many times as you like. You may not use the project, text, pattern or pictures for any other purpose nor make the project using any automated process.

All the free articles available for download on our web site are at least one year old. If you want the latest projects, designer profiles, gallery pages and more, then you need to subscribe to the quarterly Craft Creations Magazine.

Subscription Benefits:

- * A free gift with every issue.
- * 10% off every order placed with Craft Creations*.
- * £2.50 off post and packing on orders over £20*.
- * Prize competition in every issue.
- * New product information.

You can subscribe to the quarterly Craft Creations Magazine or purchase any of the back issues from our online shop.

* All Craft Creations Magazine subscribers will receive an additional 10% discount off their orders during their subscription period only. Subscribers will also receive £2.50 off post and packing on orders over £20 (after discount). These benefits are not applicable on certain items such as: Magazine Subscriptions, Gift Vouchers, Products already on Promotion, Special Offers or 'SPOF' packs and cannot be combined with any other vouchers or offers.

Craft Creations Limited
Ingersoll House, Delamare Road, Cheshunt, Hertfordshire, EN8 9HD, England.
Tel: 01992 781900 Fax: 01992 634339

The details above are correct as of 1st April 2007, but are subject to change without prior notice.