

# Golden Wedding

By Pam Palmer

## Materials Required:

3mm Quilling paper:  
Dark Green, Light Green,  
Cream, Lemon and Gold.

5mm Quilling paper:  
Cream and Deep Yellow.

45cm Length of lace edging.

Gold beads on a string.

Rubber stamp or peel off  
sticker wording.

P.V.A. Craft Adhesive.

Card mount:  
AP01U Linen Cream.

## To Make The Card:

Fold the card and lightly mark in pencil where the aperture comes on the back flap. Open the card again and add the greeting, I have rubber stamped and embossed my greeting using a heat gun, but you can use whatever media you prefer or trace over the wording on the diagram. Put the greeting well in from the oval to allow room for the lace, if you are not going to heat the card you could put the lace in first to make it easier to place the greeting.

Place the open card face down and glue the lace to the inside edge of the aperture. Make small snips on the hidden edge of the trim if necessary so that it lays flat on the card as it curves round the aperture. Fold the card and seal down with P.V.A. adhesive.

Bells: Make two of these. Join two lengths of gold paper with glue to overlap approx. 10mm.

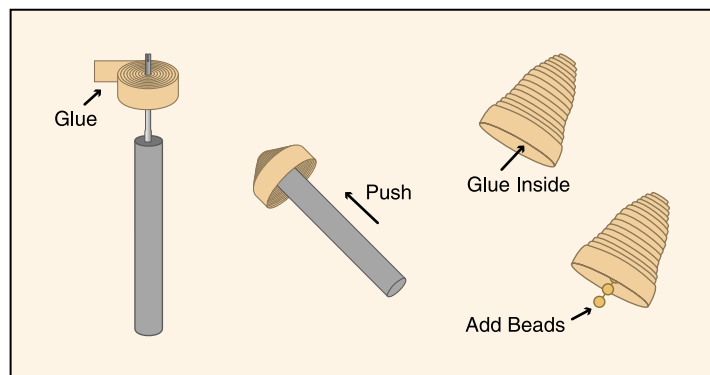

This will give you an overall length of approx. 890mm. Allow this to dry then roll into a firm but not too tight peg, glue the end so that it does not unroll. Gently push the peg into a cone shape, when satisfied with the shape run a layer of glue all round the inside, this helps to keep the shape and makes it firm. Slightly flatten the cone to make a bell shape. Cut three beads for each bell from the string of gold beads and glue them just inside the bells as shown.

Roses: Make seven of these. Each rose uses 115mm of 5mm yellow paper. Roll the strip of paper onto the quilling tool for three turns, fold the strip down. Turn the tool bringing the strip back into line as you turn then make a half turn and fold again. Repeat until you reach the end of the strip.

Remove the rose from the tool and allow it to open out a little before glueing the end.

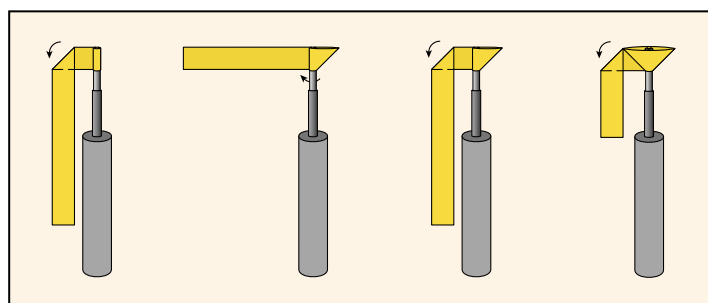

**Daises:** Make three of these. Cut a 100mm length of 5mm cream and a 70mm length of 3mm lemon. Snip evenly across the 5mm strip all the way along the long edge as shown above. Glue the end of the lemon strip to the unsnipped edge of the cream to make one long length, then beginning with the lemon, roll onto the tool and glue the end. Remove from the tool and gently fold down the snipped edge to form the petals.

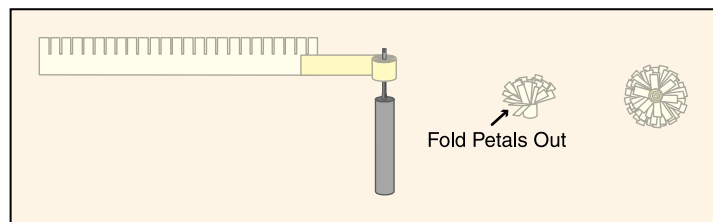
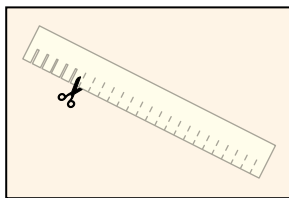

**Leaves:** Make eight of these in dark green and three light green. Using an 80mm length of paper make a loose coil and glue the end. Pinch the coil gently at both ends to shape.

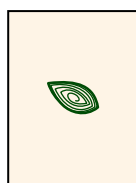

**Heart:** Make one of these. Using a 112mm length of 3mm cream paper loosely curl both ends towards the centre as shown. Fold the paper in half with the curls facing inwards and pinch to make a heart shape.

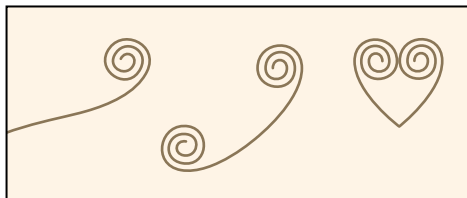

Use the diagram at the bottom of this page as a guide when positioning the pieces. Place the two bells into position on the card mount with the joins at the back so they are not visible. Place the heart above the bells with the point between them and glue all three pieces onto the card.

Make two double thickness scrolls, one facing left and one facing right, from a 120mm length of 3mm cream. Bend the paper in half without folding and glue 50mm along the open ends.

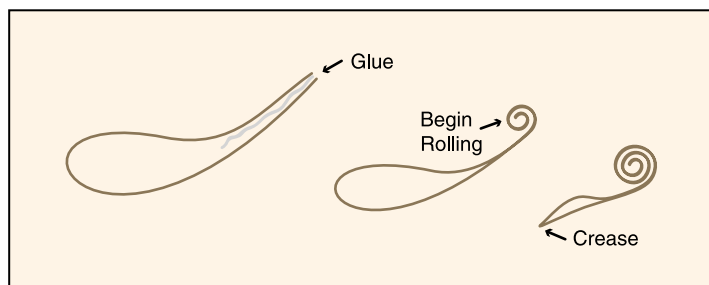

Coil the glued end loosely and crease the 'tail' just off centre so that the top line of paper bulges upwards. Glue one scroll each side of the heart as shown in the diagram.

Work out from the bells making scrolls to fit from varying lengths of light and dark green paper. Place and glue the pieces onto the card adding the leaves and flowers you have already made.

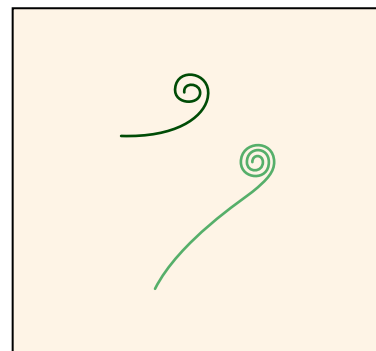

Actual Size

# Craft CREATIONS<sup>Ltd</sup> Magazine

Hello,

We hope you enjoy this free project. You may hand make copies of this project, to give away or sell, as many times as you like. You may not use the pattern, project, text or pictures for any other purpose nor make the project using any automated process.

The project was taken from a back issue of the Craft Creations Magazine.

All the articles on our web site are at least one year old. If you want the latest projects, designer profiles, gallery pages and more, then you need to subscribe to the quarterly Craft Creations Magazine.

## *Subscription Benefits Include:*

- \* A free gift with every issue.
- \* Two discount vouchers off Craft Creations products with every issue.
- \* A £2.50 off post and packing voucher with every issue.
- \* New product information.
- \* Prize competitions in every issue.

You can subscribe to the quarterly Craft Creations Magazine or purchase any of the back issues from our online shop.

<http://www.craftcreations.com/Shop/shop.html>